

INSTRUCTION MANUAL

SynScan™

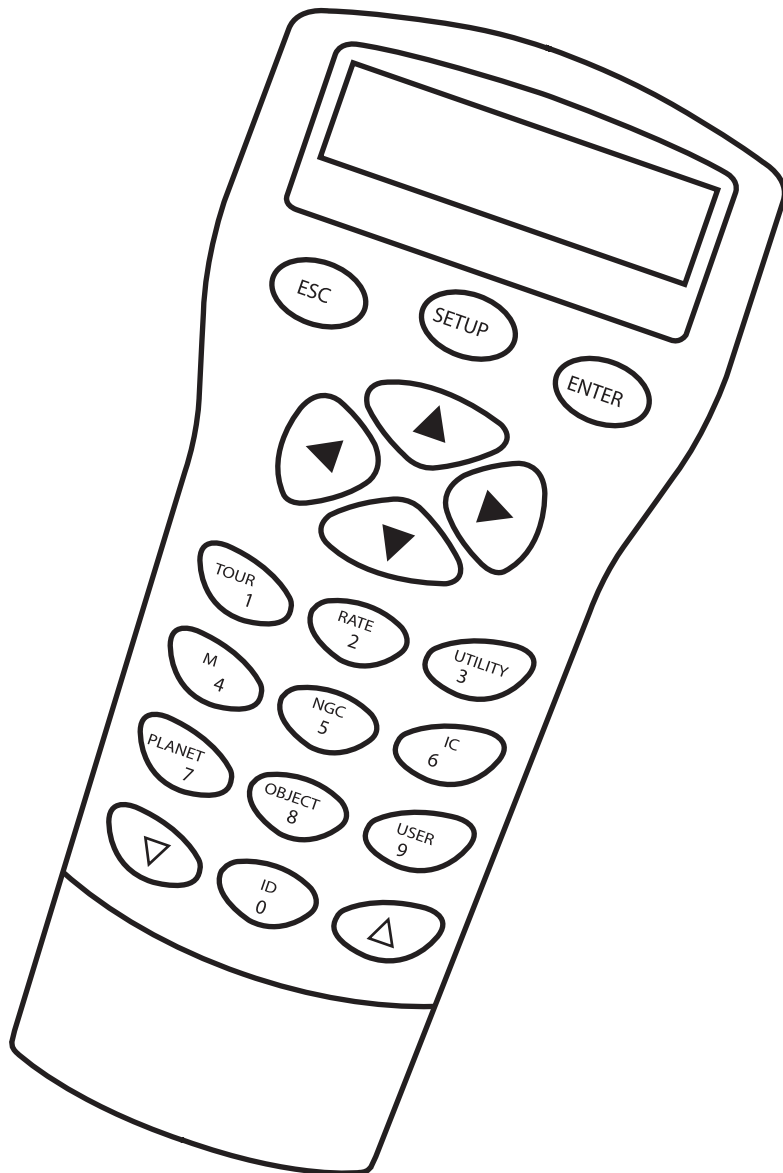

TABLE OF CONTENTS

THE SynScan™	3
Introduction to the SynScan™	3
Powering the SynScan™	3
SynScan™ Hand Control	3
HAND CONTROL OPERATION	5
Initial Setup	5
Star Alignment	6
Pointing Accuracy Enhancement (PAE)	7
OBJECT CATALOG	8
Object database in the SynScan™	8
Selecting an Object	8
OTHER FEATURES	9
Utility Functions	9
Setup Functions	9
Using the User Defined Database	10
Identifying an Unknown Object	11
Linking with a Computer	11
Auto Guiding	11
Periodic Error Correction	11
Updating the SynScan™ Firmware	13
SynScan™ MENU TREE	15
TECHNICAL SPECIFICATIONS	16
APPENDIX A - CONE ERROR CALIBRATION	I
APPENDIX B - RS-232 CONNECTION	IV
APPENDIX C - STANDARD TIME ZONES OF THE WORLD	VI



NEVER USE YOUR TELESCOPE TO LOOK DIRECTLY AT THE SUN. PERMANENT EYE DAMAGE WILL RESULT. USE A PROPER SOLAR FILTER FIRMLY MOUNTED ON THE FRONT OF THE TELESCOPE FOR VIEWING THE SUN. WHEN OBSERVING THE SUN, PLACE A DUST CAP OVER YOUR FINDERSCOPE OR REMOVE IT TO PROTECT YOU FROM ACCIDENTAL EXPOSURE. NEVER USE AN EYEPIECE-TYPE SOLAR FILTER AND NEVER USE YOUR TELESCOPE TO PROJECT SUNLIGHT ONTO ANOTHER SURFACE, THE INTERNAL HEAT BUILD-UP WILL DAMAGE THE TELESCOPE OPTICAL ELEMENTS.

THE SynScan™

Introduction to the SynScan™

The SynScan™ is a precision-engineered instrument that will allow you to easily find and enjoy viewing night sky treasures, such as planets, nebulae, star clusters, galaxies and much more. The hand control allows you to point your telescope at a specific object or even tour the skies at the touch of a button. The user friendly menu system allows automatic slewing to over 13,740 objects. Even an inexperienced astronomer can master its variety of features in a few observing sessions. Below is a brief description of the individual components of the SynScan™ hand controller.

Powering the SynScan™

The SynScan™ should be powered by 11-15V DC power supply (tip-positive) capable of producing continuous current of minimum 2 amps. Correctly plug the power cord into the 12V DC outlet on the the mount (See Fig.a and b for HEQ5 mount, Fig.a-1 and b-1 for EQ6 mount). Flip the Power Switch to the "on" position to turn on the power.

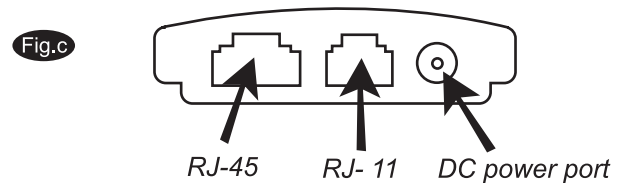
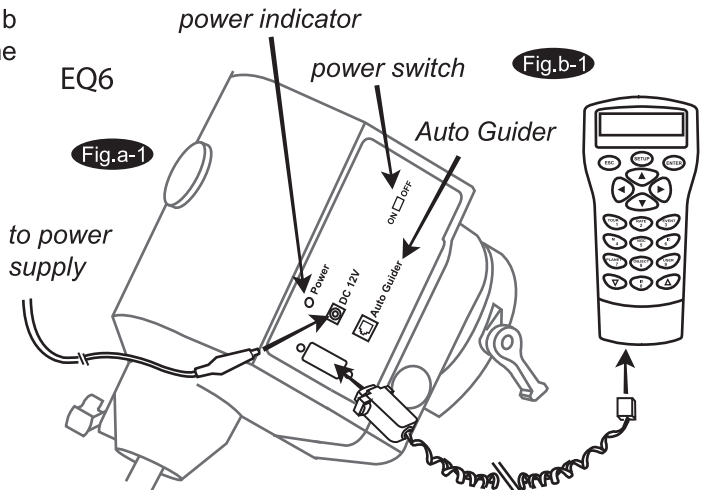
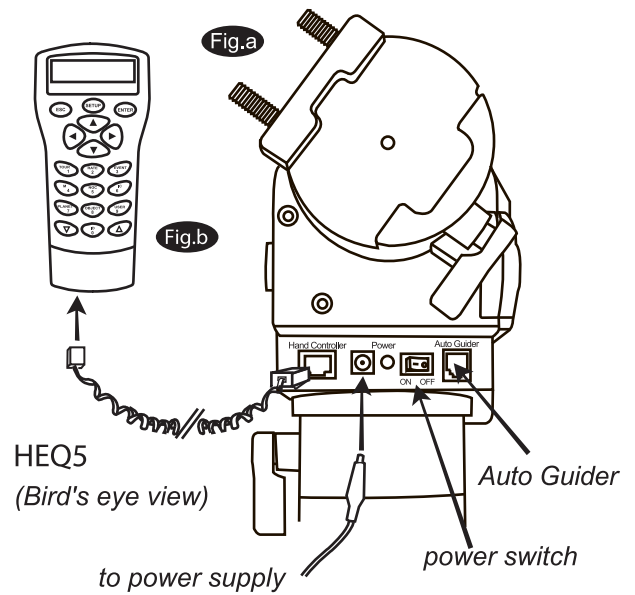

The power indicator will flash when the power is low. Continue to use the battery at this point may damage the battery. The power indicator will flash rapidly when the power is extremely low. Continue to use the same battery may damage the SynScan™ system.



In SynScan firmware version 3.10 or later, you can check the power voltage detected by hand control under "Utility \ Show Information \ Power Voltage" submenu

SynScan™ Hand Control

The SynScan™ hand control cable for the HEQ5 has a RJ-45 connector on both ends. Plug one end into the hand control (Fig.c) and the other into the outlet on the mount (Fig.b). Push the connector into the outlet until it clicks into place. The SynScan™ cable for the EQ6 mount has a RJ-45 connector on one end and DB9 on the other. Plug the RJ-45 connector into the hand control (Fig.c). Push the connector into the outlet until it clicks into place. Plug the DB9 connector into the outlet on the mount. Tighten the screws to secure the connector in place (Fig.a-1). The RJ-11 6-pin port is used for RS-232 communications between the SynScan™ and a computer or other devices. (See "Linking with a Computer" for details.) The DC power port allows independent use of the SynScan™ hand control for users who wish to browse the database without connecting to the telescope (Fig.c).



The DC power port on the hand control is for hand control stand-alone applications only. For telescope applications, use the 12V DC outlet on the mount.



To connect the SynScan to a PC, use only the RS-232 cable provided with the mount.

The SynScan™ Hand Control allows direct access to all the motion controls of the telescope and a database with a range of preset objects. The Hand Control comes with a dual-line, 16 character display screen that is backlit for comfortable viewing of the telescope information and scrolling text. To explore the many functions that the SynScan™ has to offer, there are 4 main categories of control on the Hand Control (Fig.d):

Mode keys

The mode keys are located near the top, close to the LCD display. They include the **ESC**, **ENTER**, and **SETUP** keys:

ESC key is used to escape from a certain command or to go back a level in the menu tree.

ENTER key is used to select the functions and submenus in the menu tree, and to confirm certain functional operations.

SETUP key is a quick hot key that takes you to the Setup submenu.

Directional keys

The directional keys allow complete control of the telescope at almost any step in the SynScan's operation. These controls are locked out when the telescope is slewing to an object. They are normally used to initially align, center objects in the eyepiece, and manual guiding. The left and right directional keys can also be used to move the text cursor when entering data to the hand control.

Scroll Keys (Fig.e)

The up and down scroll keys allow you to scroll up and down within the menu tree or selections.

Dual Purpose keys

These keys range from the middle to the bottom of the hand control. They serve two distinct purposes—data entry and quick reference hot keys.

TOUR key (Fig.f) takes you on a preset tour across the sky you are currently under.

RATE key (Fig.f) changes the speed rate of the motors when the direction keys are pressed. There are 10 speeds to choose from: 0 (slowest) to 9 (fastest).

UTILITY key (Fig.f) shows functions such as Show Position, Display Time...etc.

USER key (Fig.f) gives access to up to 25 user-defined coordinates.

ID key (Fig.f) identifies the object the telescope is currently pointing to.

NGC, IC, M, PLANET, and OBJECT keys (Fig.g) allow direct access to SynScan™ database of over 13,740 objects.

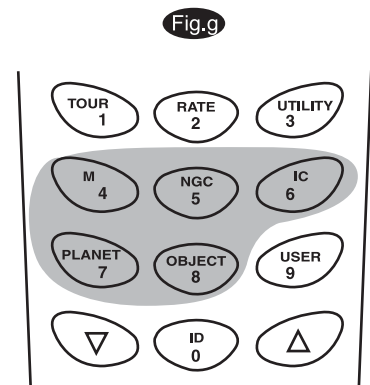
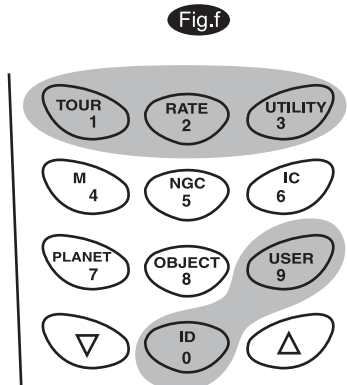
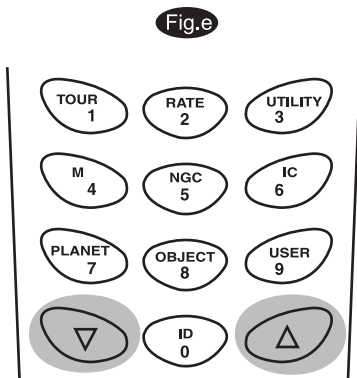
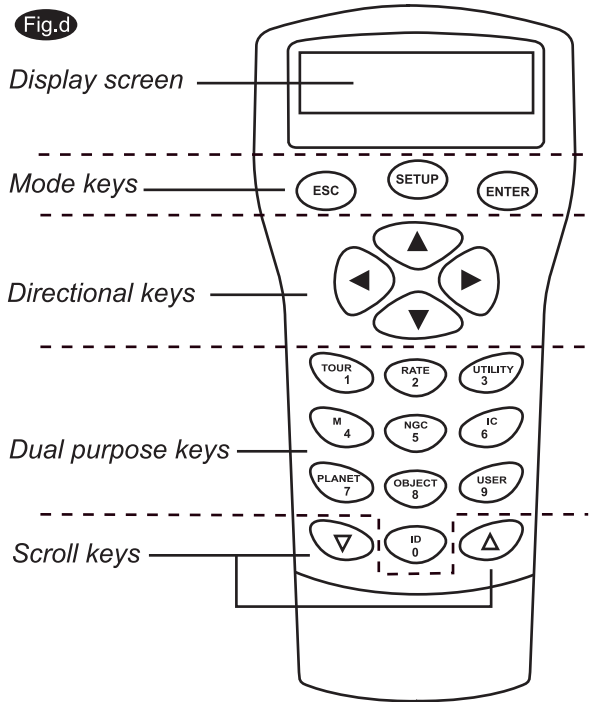

HAND CONTROL OPERATION

Initial Setup

1. Perform the Polar alignment using the polarscope. If the polar alignment method of your choice requires the hour angle of Polaris and clock position. This information will be provided after setting the Daylight Saving at step 10. You may skip the polar alignment and proceed to step 2. Polar alignment can be performed after the hand control displays the hour angle of Polaris and clock position at step 11. Make sure that the telescope is returned to its home position after polar alignment.
2. Point the telescope roughly to the North Celestial Pole (or Polaris) if you are in the Northern Hemisphere. Point to the South Celestial Pole if in Southern Hemisphere. Make sure the counterweight rod is pointing down as seen in Fig. h. This will be the home position of the telescope.
3. Flip the Power Switch on the mount to the "ON" position to turn on the power.
4. The initial screen displayed on the hand control is the Version Screen. Press ENTER to proceed. The hand control will display a warning concerning pointing the telescope at the sun without proper equipment. If you have read the message already, pressing ESC will bypass the message and skip to the next step.

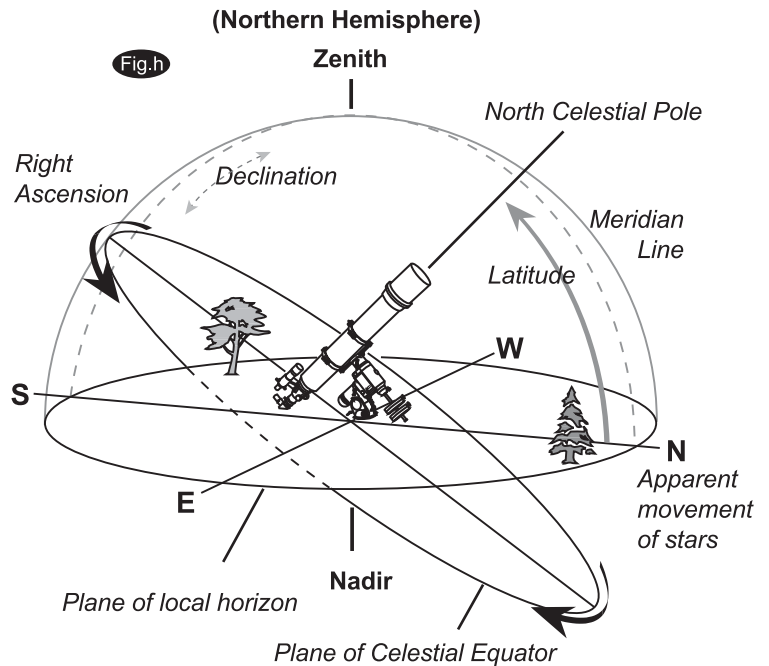

The hand control's red light will become dimmer and the key pads will turn off if idle for 30 seconds. Pressing any key turns it back on.

5. If SynScan GPS is in use, the hand control will prompt for the user to enter time zone and daylight saving. After the information is entered, the GPS receiver will retrieve the current Longitude, Latitude and Universal Time automatically. This may take up to 90 seconds. Please see SynScan GPS Instruction Manual for details. Skip to step 11.
6. If no SynScan GPS is connected, or the GPS is unable to retrieve information, the SynScan hand control will prompt for the user to enter the current latitudinal and longitudinal position using the numeric keypad. First enter the longitudinal coordinate, followed by the latitudinal coordinate. Use the scroll keys to choose between W or E, and N or S. Pressing the left or right directional keys will move the cursor to the previous or next number. Press *ENTER* to confirm. The format you enter should look like this: 123 04' W 49 09'N.
7. Enter your current time zone in hours (see Appendix C), using the scroll keys and numeric key pad (+ for East, - for West). Press *ENTER* to confirm. The format you enter should look like this if you are in Pacific Standard Time (PST): -08.
8. Enter the date in the following format mm/dd/yyyy using the numeric keypad. Press *ENTER* to confirm.
9. Enter your current local time using the 24 hr time mode (e.g. 2:00PM=14:00). Press *ENTER* to view the time you just entered. If it is incorrect, press *ESC* to go back to the previous screen. If correct, press *ENTER* again to proceed to the daylight saving setting.
10. The SynScan™ will prompt "DAYLIGHT SAVING?". Use the scroll keys to make the selection and press *ENTER* to confirm.
11. Now the SynScan™ will display the hour angle of Polaris at present time (e.g.19:20), and the clock position (e.g. 08:19), which is the correct orientation of the smaller circle in the view of polar scope. This information comes in handy when performing the Polar Alignment.
12. Press *ESC* or *ENTER* on the hand control to exit from the information display. The hand control will ask "Begin alignment?". Press "1" or *ENTER* to start the star alignment procedure. Press "2" or *ESC* to skip the alignment and exit to the Main Menu.



If a mistake was entered into the SynScan™ hand control, press the *ESC* key to go back to the previous menu, and press *ENTER* to start again.

Star Alignment

In order for the SynScan™ to correctly point to objects in the sky, it must first be aligned to one to three known positions (stars) in the sky. As the Earth rotates on its axis every 24 hours, astronomical objects appear to move through the sky following an arc. With the supplied information, the telescope can replicate a model of the sky and the movements of astronomical objects. Star alignment can be done anytime during the observing session by choosing Alignment under SETUP MODE, in the Main Menu.

There are three ways to align the SynScan™ depending on your demand for accuracy. If you are using the SynScan™ for the first time, we recommend that you begin with the Three Star Alignment. In most cases, this produces the most accurate alignment among the three methods. Before performing any of the alignment methods, be sure that your finderscope is well aligned with the telescope tube. See the next page for tips on how to choose the alignment stars. Below describes a step-by-step procedure on how to perform the Three Star Alignment:

Three-Star Alignment

1. In the alignment screen, select 3-Star Align using the scroll keys. Press *ENTER* to confirm.
2. The SynScan™ will provide a list of stars available in your current sky for you to choose as the first alignment star. Using the scroll keys, choose an appropriate star from the list provided and press *ENTER*. The telescope will start slewing towards it. When the telescope stops slewing, adjust its position with the directional keys until the star is centered on the crosshairs in the finder scope. Now look through the eyepiece and adjust the telescope so that the object is centered in the field of view of the eyepiece. Press *ENTER* to confirm.



The slewing speed can be adjusted by pressing on the *RATE* button. Then choose a number between 0 (slowest) - 9 (fastest).



SynScan™ will beep once when it has finished slewing to an object. Do not try to adjust the telescope before you hear the beep. SynScan™ will only respond to the *ESC* key while slewing.

3. SynScan™ will provide a list of objects for the second alignment star. Choose a star using the scroll keys and press *ENTER*. Repeat the centering procedure for the second star and press *ENTER* to confirm.
4. SynScan™ will once again provide a list of objects for the third alignment star. Choose a star from the list and press *ENTER*. Once again, repeat the centering procedure for the third alignment star.
5. If appropriate stars have been chosen and aligned to, the SynScan™ hand control will display "Alignment Successful". Otherwise, the warning "Alignment Failed" will show and the alignment will have to be done again.

Two-Star Alignment

Two-Star Alignment requires only two alignment stars but, without Cone Error Calibration (see Appendix A), it may produce lesser pointing accuracy than the Three-Star Alignment. Below describes a step-by-step procedure on how to perform the Two-Star Alignment:

1. In the alignment screen, select 2-Star Align using the scroll keys. Press *ENTER* to confirm.
2. The SynScan™ will provide a list of stars available in your current sky for you to choose as the first alignment star. Using the scroll keys, choose a star you are most familiar with and press *ENTER*. The telescope will start slewing towards it. When the telescope stops slewing, adjust its position with the directional keys until the star is centered on the crosshairs in the finder scope. Now look through the eyepiece and adjust the telescope so that the object is centered in the field of view of the eyepiece. Press *ENTER* to confirm.
3. SynScan™ will provide a list of objects for the second alignment star. Choose a star using the scroll keys and press *ENTER*. Repeat the centering procedure for the second star and press *ENTER* to confirm.
4. If appropriate stars have been chosen and aligned to, the SynScan™ hand control will display "Alignment Successful". Otherwise, the warning "Alignment Failed" will show and the alignment will have to be done again.

One-Star Alignment

It requires only one alignment star but, without accurate polar alignment and cone error calibration (see Appendix A), it may produce lesser pointing accuracy than the other alignment methods. Refer to the HEQ/EQ6 manual for information on how to perform accurate polar alignment. Below describes a step-by-step procedure on how to perform the One-Star Alignment:

1. Make sure the telescope has been polar aligned.
2. In the alignment screen, select *1-Star Align* using the scroll keys. Press *ENTER* to confirm.
3. The SynScan™ will provide a list of stars available in your current sky for alignment. Using the scroll keys, choose a star you are most familiar with and press *ENTER*. When the telescope stops slewing, adjust its position with the directional keys until the star is centered on the crosshairs in the finderscope. Now look through the eyepiece and adjust the telescope so that the object is centred in the field of view of the eyepiece. Press *ENTER* to confirm.
4. Once completed, SynScan™ will display "*Alignment Successful*".



Following is some pointers on how to choose appropriate alignment stars:

One Star: Choose a star closer to the Celestial Equator (smaller declination absolute value).

Two Star: Choose two stars that are on the same side of the meridian, and at least 3 hours apart in RA and 3° apart in Dec. If you suspect that the polar alignment is off by 1° and above, choose two stars that are well more than 3° but less than 60° apart in Dec.

Three Star: For the first two alignment stars, follow the same guideline as choosing for the Two Star Alignment. For the third alignment star, choose a star that is on the opposite side of the meridian of the first two stars. Both first alignment star and third alignment star should have an absolute value of 30° to 70° in Dec. If the first chosen star has a small Dec (<30°), the Dec of the third star should be at least 50°. The following formula can be used as a guideline when determining the correlation between the first and third stars in Dec: $140^\circ > \text{Abs}(\text{Dec}1) + \text{Abs}(\text{Dec}2) > 60^\circ$

In the SynScan version 3.10 or later, these criteria is implemented in the software. The list of alignment stars contains only the appropriate stars.

Pointing Accuracy Enhancement (PAE)

The three star alignment methods provide alignment adequate for any visual observing purpose. For applications that require extra high precision in a particular part of the sky, the SynScan™ provides a Pointing Accuracy Enhancement (PAE) function to further improve the accuracy. The PAE can be performed in up to 85 zones to cover the whole sky. The area(s) where the chosen alignment star(s) is located should be already mapped out accurately by the SynScan™. Further accuracy enhancement is not necessary. The following provides a step-by-step procedure on how to perform PAE:

1. Choose a star as reference object from a star chart or planetarium software. This star should be a known, bright object that is currently located in the same part of the sky with the object of your interest.
2. Find the reference object in the SynScan™ hand control database and go-to the object. If the mount is under the control of the planetarium software, click on the object to slew to it.
3. Adjust the telescope so that the reference object is in the center of the eyepiece or CCD view.
4. Press and hold down the *ESC* key for 2 seconds. The hand control will display "Re-center" and the name of the reference object will appear in a blinking mode (3 times). If the go-to command is sent from the planetarium software, instead of the name of the object, the hand control will display "Last goto object".
5. Make sure that the reference object is still in the center of the view and press *ENTER*. If you do not wish to record the result, press *ESC* to abort the operation. After pressing *ENTER*, the SynScan™ will record the amount of pointing inaccuracy and recalculate the model of the sky. Now the pointing accuracy of this particular part of the sky should be greatly improved.



The result for the star alignments and PAE is stored in the hand control even after the power has been shut off. You will only need to perform the star alignment once as long as these two criteria are met: 1. The telescope is moved to its home position (Park the telescope) before turning off the power. 2. The telescope setup, including the mount, has not been moved. Accessory change is acceptable as long as it is done with great caution. When the hand control is turned on for the next time, make sure that the time entered during initial setup is based on the same source as last time. For example, if you enter the time on your watch during this observing session, the time you enter next time should also be read from your watch.

OBJECT CATALOGUE

Object database in the SynScan™

The SynScan™ comes with a vast database with over 13,740 objects coordinates and information all available in the palm of your hand. The database contains the following catalogs:

Solar System - The other 8 planets of our solar system, plus the Moon.

Named Star - A list of 212 best known stars from the SynScan™ database.

***NGC** - 7,840 of the brightest deep sky objects from the Revised New General Catalog.

IC - 5,386 of standard stars and deep sky objects from the Indexed Catalog.

Messier - Complete list of 110 Messier objects.

Caldwell - Complete list of 109 Caldwell objects.

Double Stars - Includes 55 well-known double stars.

Variable Stars - Includes 20 will-known variable stars.

Selecting an Object

Once the telescope has been aligned. You can now access and view the 13,740 different objects in the SynScan™ database. There are three methods of selecting a celestial object to view:

SHORTCUT KEYS

(Fig.i)

TOUR - Takes you on a preset tour across your current sky. It will automatically choose from the database the brightest and most beautiful deep-sky objects for your viewing pleasure. Use the down scroll key to view through the deep sky objects. Choose the desired object by pressing **ENTER**. It will show the coordinate of the chosen object. Pressing **ENTER** once more will cause the telescope to slew to the object.

M, NGC, IC - These shortcut keys give you access to the most popular celestial catalogues to date. Each Catalog has a set number of objects to choose from. Use the numeric keys to select an object by entering its number. Pressing **ENTER** will display its coordinate. Primary information such as size, magnitude, and constellation are obtained by pressing the scroll keys. Pressing **ENTER** once more will cause the telescope to slew to the object.

PLANET - This shortcut key takes you straight to the Planets sub menu in the database. Use the scroll keys to scroll through the list of planets in our solar system. Press **ENTER** to view its coordinates, and **ENTER** once more to slew to the planet.

USER - This will take you to the database that you have defined for yourself. You can enter a new location or recall the objects that have been previously saved (see Using the User Defined Database).

OBJECT KEY

(Fig.j)

The **OBJECT** key takes you to the Objects Catalogue, where you have complete access to over 13,740 celestial objects in the database. (See Object database in the SynScan™ and the menu tree.)

MENU

(Fig.k)

In the Main Menu, scroll down to **OBJECT CATALOG** and press **ENTER**. Similar to the **OBJECT** key, this gives you the complete access to all 13,740 celestial objects in the database. (See Object database in the SynScan™ and the menu tree.)

Fig.i

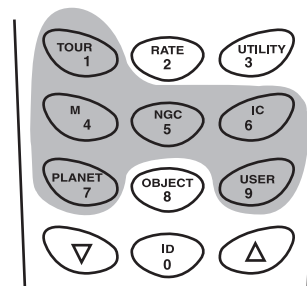

Fig.j

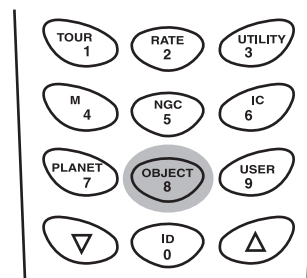
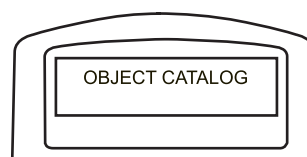

Fig.k



OTHER FEATURES

Utility Functions

Utility Functions are useful tools that provide simple, one-step processes to your SynScan™:

Show Position - This displays the coordinates of the location where the telescope is currently pointed.

Show Information - This includes submenu Time, Version, Temperature and Power Voltage.

Time - This displays the local time and local Sidereal time.

Version - This displays the hardware, firmware, and database version of the SynScan hand control. This menu also displays the firmware version of the motor control board. Use the scroll keys to scroll up or down to view the version numbers.

Temperature - This displays the temperature detected from the thermal sensor in the hand control in both Celsius and Fahrenheit degrees.

Power Voltage - This displays the power voltage detected from hand control in Volts.

Polaris Pos. - This displays the clock position of Polaris viewed in the polar scope and current Hour Angle (HA) of Polaris. It is helpful for determining the relative position between the NCP and Polaris for polar alignment purpose.

Display Time - This displays the local time and local Sidereal time.

Park Scope - This moves the telescope to the Home position.

PEC Training - See Periodic Error Correction for information.

PAE - See Pointing Accuracy Enhancement (PAE) for details.

GPS - When SynScan GPS is in use, this displays Longitude, Latitude, Universal Time, Date, Local Time, Local Sidereal Time, Elevation, and GPS signal quality etc. See SynScan GPS Instruction for details.

Setup Functions

The Setup functions allow you to change any system variable or information regarding location, time, date, and alignment configurations. To access the Setup Functions, either press *SETUP* key on the key pad or scroll to *SETUP* under menu option using the scroll keys. Below lists the different types of functions available to you, and their purposes.

Date - Allows you to change the date entered at the initial setup.

Time - Allows you to change the current time.

Observing site - Allows you to change the current location.

Daylight Savings - Allows you to change the Daylight Savings option.

Alignment - Allows you to perform the star alignment.

Set Backlash - This feature allows you to insert a value for each axis to compensate for its backlash. For better pointing accuracy, it is important that the backlash value is set to be equal or greater than the real amount of backlash between the gears. The default setting of the backlash is 10' 00" (10 arcmin. and 0 arcsec.). Use the numeric keys to enter the desired value and press the RIGHT directional key to move the cursor to the next digit. First set the value for R.A. Press *ENTER* to proceed to Dec.

Set Tracking

- Sid. Rate: This activates tracking in Sidereal rate (R.A. Tracking).
- Lunar Rate: This activates tracking in Lunar rate (R.A. Tracking).
- Solar Rate: This activates tracking in Solar rate (R.A. Tracking).
- PEC + Sidereal Rate: Sidereal rate with Periodic Error Compensation.
- Stop Tracking: This stops the tracking instantly.

Auto Guide Speed - When using an autoguider, this sets the guiding speed to 1X, 0.75X, 0.5X, 0.25X, or 0.125X sidereal rate.

Handset Setting - Allows you to change LCD Contrast, LCD Backlight, LED Backlight on keypads and Beep Volume. Use RIGHT or LEFT direction key to increase or decrease value.

Using the User Defined Database

SynScan™ allows you to save up to 25 objects in the user defined database.

Saving an object to the database

1. In the Main Menu, use the scroll keys to scroll down the list until you find Object Catalog. Press *ENTER*.
2. Select User Defined in the Object Catalog scroll list and press *ENTER*.



The User Defined menu can also be accessed by pressing the quick reference hot key "USER" (number 9). Fig.l

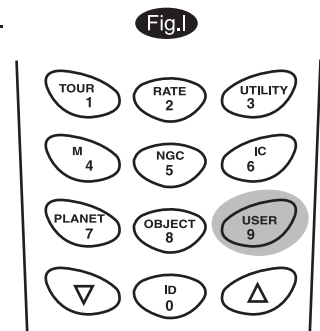

4. The first available selection in the Object Catalog is Recall Object. This is where you select previously-saved objects to view. Use the scroll keys to scroll down to "Input Coordi.>" and press *ENTER*.
5. The SynScan™ stores the user-defined objects in two formats- R.A/Dec and Alt/Az. Press 1 for the R.A/Dec. format and 2 for the Alt-Azimuth format.
6. By default the SynScan™ will display the R.A./Dec or Alt/Az coordinates where the telescope is currently pointed. In the case of R.A/Dec format, the coordinate readout will be similar to this: "22h46.1m +90° 00'" (Fig.m) which means 22 hours and 46.1 minutes in R.A. and "+90° 00'" in Dec. Change the coordinates using the numeric keypad and scroll keys. Use the RIGHT or LEFT directional keys to move the cursor to the next or previous digit. Press *ENTER* to save.

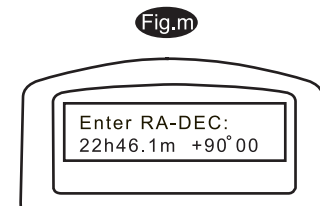

If the R.A./Dec coordinate entered does not exist, the SynScan™ hand control will not respond when the *ENTER* key is pressed. Check the entry for mistake and re-enter the correct coordinate.

7. To store an object/location in Alt/Az format, first point the telescope to the desired location to obtain the Alt/Az value, then press *ENTER* to save.
8. After the coordinates have been saved, the SynScan™ will display an User Object number as shown in Fig.n. Use the scroll keys to change to the number you wish to represent the coordinates and press *ENTER*.
9. The SynScan™ will display "View Object?" and the User Object number you just entered. Press *ENTER* to go to the object or *ESC* to return to the Input Coordinate menu.

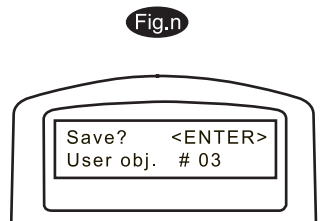

The User Object number displayed may not be a vacant one. If you are unsure which numbers are vacant, it is recommended that you first check for the available numbers by recalling the saved user objects.

Recalling an user defined object

1. See Step 1-4 of "Saving an object to the database" for details on how to access to the User Defined menu. Select Recall Object and press *ENTER*.
2. Use the scroll keys to browse through the User Object number until the number representing the object you wish to view is present. Press *ENTER* to show its coordinate. Press *ENTER* again to slew to the object. The hand control will not respond if a vacant User Object number is selected. Use the scroll keys to choose another number and try again.



If the recalled object is below horizon, the SynScan™ hand control will display "Below Horizon !! Try another obj." and automatically return to the Recall Object menu.

Identifying an Unknown Object

SynScan™ has the ability to identify the unknown object the telescope is currently pointing at. To do so, simply:

1. Press the *ID* key (Fig.o) or scroll down to *IDENTIFY* in the main menu and press *ENTER* to identify the object.
2. The hand control will display a list containing the closest known object in each M, IC, NGC, and Named Star catalogs and its distance to the exact location where the telescope is pointed. Use the scroll keys to view these objects.
3. Press *ESC* to exit from this function.

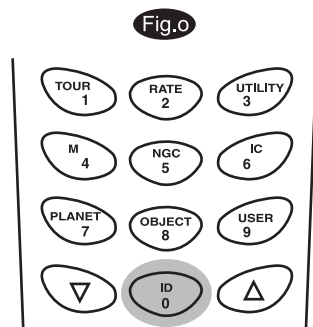

Linking with A Computer

Another feature of SynScan™ is the ability to connect to a computer via a serial communication cable. Many commercially available planetarium softwares can be used to control SynScan™. SynScan™ Version 3.00 and later is compatible with Celestron 5i/8i and NexStar GPS command protocol.

1. Make sure that the telescope has been aligned.
2. Connect the RS-232 cable to the RJ-11 connector on the hand control and to the COM-port of your computer (Fig.p)



Do not use RS-232 cable other than the one provided to connect between the hand control and your computer. It may damage your computer or the hand control. If you are making your own cable based on the information provided in Appendix B, make sure that only pin 2, 3 and 5 connect to the com connector on your computer.

3. In the planetarium software of your choice, choose "Celestron NexStar 5i" or "Celestron 8/9/11 GPS" in the driver setup menu and follow the instructions provided by your program to establish the connection to the telescope. The SynScan™ should be under the full control of your computer once the connection is successfully established.
4. When you are finished, follow the instructions provided by your software to close the connection to the telescope.

Fig.p

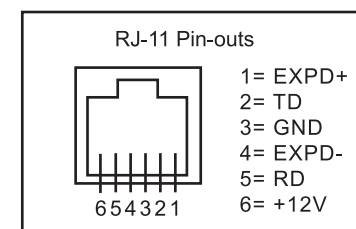
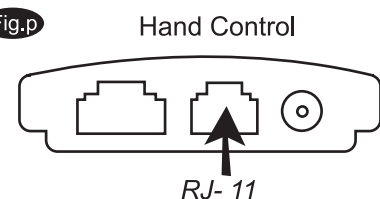

See Appendix B for more information on RS-232 connection.

Auto Guiding

The SynScan™ has a designated autoguider interface on the mount for use with an auto guider (see Fig.a, a-1). The pin-outs on the 6 pin modular connector is ST-4 compatible and can be used for most autoguiders on the market. Refer to Fig.q when connecting the autoguider cable to the SynScan™ and calibrating the autoguider. Relay box can be added for extra protection. Note that the four inputs are active-low, with internal pull-ups. Guiding speed can be adjusted using the Auto Guide Speed function in the Setup Menu.

Fig.q

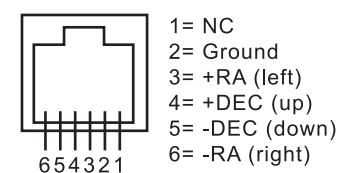

Periodic Error Correction

Periodic Errors are found in almost all worm gears due to slight eccentricities and misalignments. The PEC (Periodic Error Correction) function provides a manual correcting method to reduce the amplitude of the worm errors. By recording a full cycle of guiding actions versus motor shaft angle, SynScan™ can work to compensate for the drifting in the RA sidereal tracking caused by the periodic errors. Below describes a step-by-step procedure on how to perform the PEC:

PEC Training function is recommended for advanced users interested in long-exposure astrophotography only. Careful guiding is required. Regular sidereal tracking is adequate for all casual visual use of the SynScan™ and PEC Training is not required.



Required accessory: Illuminated reticle eyepiece with double crossline pattern capable of producing at least 300X magnification in combination with your telescope. The true field of view should not exceed 10 arc min. See "Choosing the appropriate eyepiece" in the HEQ5/EQ6 manual for more information on calculating the field of view.

PEC Training

1. Perform the accurate Polar Alignment method (see the HEQ5/EQ6 manual).
2. Slew or manually point the telescope to a star with smaller DEC coordinate. This object will be used as the guide star.
3. Activate Sidereal Tracking from the Setup Menu (see Setup Functions). Once the tracking has started, press *ESC* to go back to the Setup Menu.
4. Rotate the reticle eyepiece until one set of the lines becomes parallel to (or matches) the R.A. movement of the telescope (see step 2 to 4 of the Cone Error Calibration for more information on how this is done.)
5. Move the guide star back at the center of the eyepiece view using the direction keys.
6. On the hand control, select PEC Training in the Utility Functions and press *ENTER*.



Utility Functions can be easily accessed by pressing the *UTILITY* quick reference hotkey on the keypad.

7. Select the R.A. guide speed for the PEC training.
8. The SynScan™ hand control will display the current time once the guide speed is selected, indicating that the recording has begun.
9. Using the *LEFT* or *RIGHT* direction key only, move the telescope so the guide star remains at the center of the eyepiece view (Fig.r, s). Repeat whenever necessary.

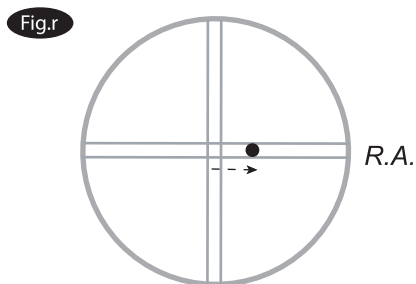

The Guide star drifts away from the center

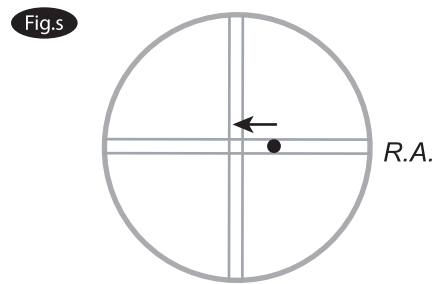

Adjust the telescope to move the guide star back to the center

10. For 8 minutes (10 minutes and 30 seconds for HEQ5), the EQ6 SynScan™ hand control records the manual guiding actions in order to characterize the periodic errors. Pressing *ESC* will stop the recording immediately and exit from the PEC training function.



Guiding actions are recorded even when the PEC training is stopped midway. In this case, the PEC+Sidereal tracking will not be accurate until a full cycle of the PEC training is performed.

11. The SynScan™ will beep and display "Record completed" when the training time is up. Press any key to exit from the PEC training.

Play back the PEC record

PEC tracking can be activated under the Setup Menu or pressing the *SETUP* quick reference hotkey on the keypad when needed. In the Setup Menu, choose Set Tracking, then PEC+Sidereal. SynScan™ will play back the corrections you made during the PEC training cycle and start tracking with periodic error compensated.



The SynScan™ will continue to track in the PEC+Sidereal mode until another tracking mode is selected. If the power is turned off while the SynScan™ is under the PEC+Sidereal mode, the hand control loses synchronization with the R.A. worm gear and the PEC Training will have to be performed again when the power is turned back on. To avoid this, be sure to return the telescope to its home position by selecting *PARK SCOPE* under the *UTILITY FUNCTIONS* before turning off the power.

Updating the SynScan™ Firmware

From version 3.0 onward, the SynScan™ firmware is user upgradeable. Users can download the latest version of the SynScan™ firmware from the Sky-Watcher web site and easily update their hand controls.

System requirements

SynScan™ Hand Control of version 3.0.or later.

Windows95 or later

An available RS-232C communication port on the PC.

PC link cable that comes with the SynScan™ hand control.

DC power supply with 7.5~15V/100mA output. Power plug should be 2.1mm diameter, tip positive.

Preparing your PC for the update

1. Create a folder for all SynScan™ related files on your computer and name it SynScan.
2. Visit the Support Page of the Sky-Watcher website at: <http://www.SkywatcherTelescope.net/Support.html>.
3. Download and save the SynScan™ Firmware Loader to the SynScan™ folder on your computer. You may create a shortcut on the desktop for quick access in the future. You will only need to download this software once. Once it is saved on your computer, only the firmware data file is needed for future updates.
4. Download and save the firmware data file named SynScanVXXXX.ssf to the SynScan folder. (The XXXX indicates the version number of the firmware.)

Updating the SynScan™ Hand Control

1. Plug the RJ-11 end of the PC link cable into the jack in the middle socket on the hand control (Fig.c). Push the connector into the hand control until it clicks into place. Plug the other end of the cable, the DB9 connector, to the RS-232 port on your PC.
2. Press and hold down the key "0" and "8" simultaneously, then plug the power cord into the hand control, as shown in Fig.t.
3. The hand control will give a beep, indicating a successful start up. The SynScan™ will display: "SynScan™ Update Ver. x.x" on the LCD screen, as seen in Fig.u.
4. Run the SynScanFirmwareLoader software on your PC. Once the program is launched, you should see a window as Fig.v. The "HC.Version" button provides the version number of the hardware, firmware and database of your hand control. It is for your reference only. You will not need it for the update.

Fig.t

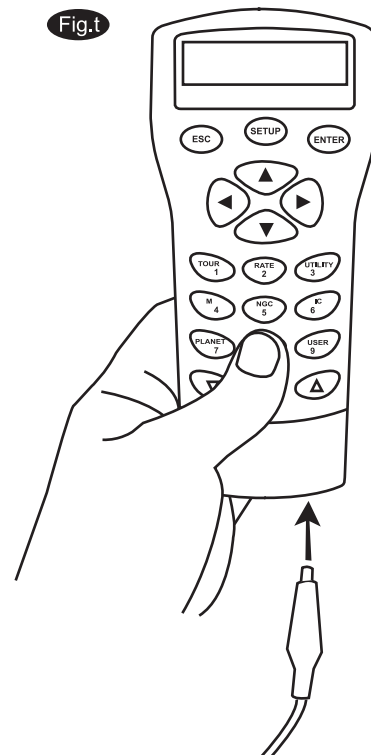

Fig.u

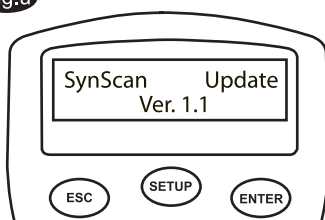
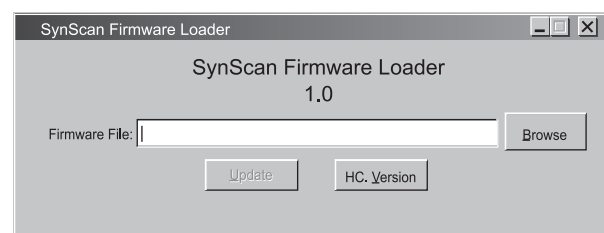
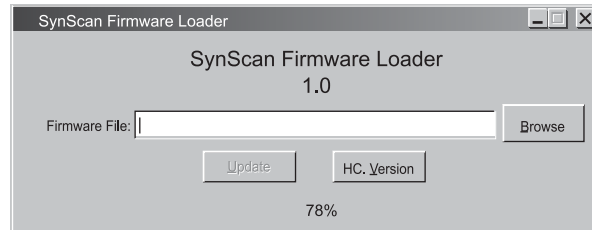

Fig.v



- Click "Browse" to select the SynScanVXXXX.ssf file in the SynScan folder. Click "Update" to start downloading the new firmware into your SynScan™ hand control. You will see the status of the update below the "Update" and "HC. Version" buttons (Fig.w).

Fig.w



- When the download is complete, the status will show "Update Complete". The SynScan™ hand control is now updated to the newest firmware. Generally it takes about 30 seconds to update the firmware. It may take longer if you are using an USB-to-RS232 converter.



If the error message "Can not connect to a SynScan hand control" is shown, check the cable connection and the PC link cable itself. Make sure it is all in good working condition. Close all applications that may be occupying the RS-232 port and try again.



If you receive the error message "Firmware update failed...", reset the hand control by removing the power plug and then re-connecting it. Repeat the update procedure.



By default, the data communication rate between SynScan™ hand control and the PC is set to be 115kbps. The RS-232C port on some PCs may not support such high rate. If the update process fails after a few tries, you can reduce the rate by pressing the "SETUP" key on the hand control after the power supply is plugged in. This will reduce the data rate to 9.6 kbps . The LCD screen will show the word "Lo" in the lower right hand corner to indicate that it is now in low communication rate. The steps for updating the firmware remain the same except that now it takes longer to complete (about 240 seconds).

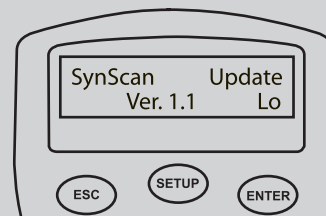

SynScan™ MENU TREE

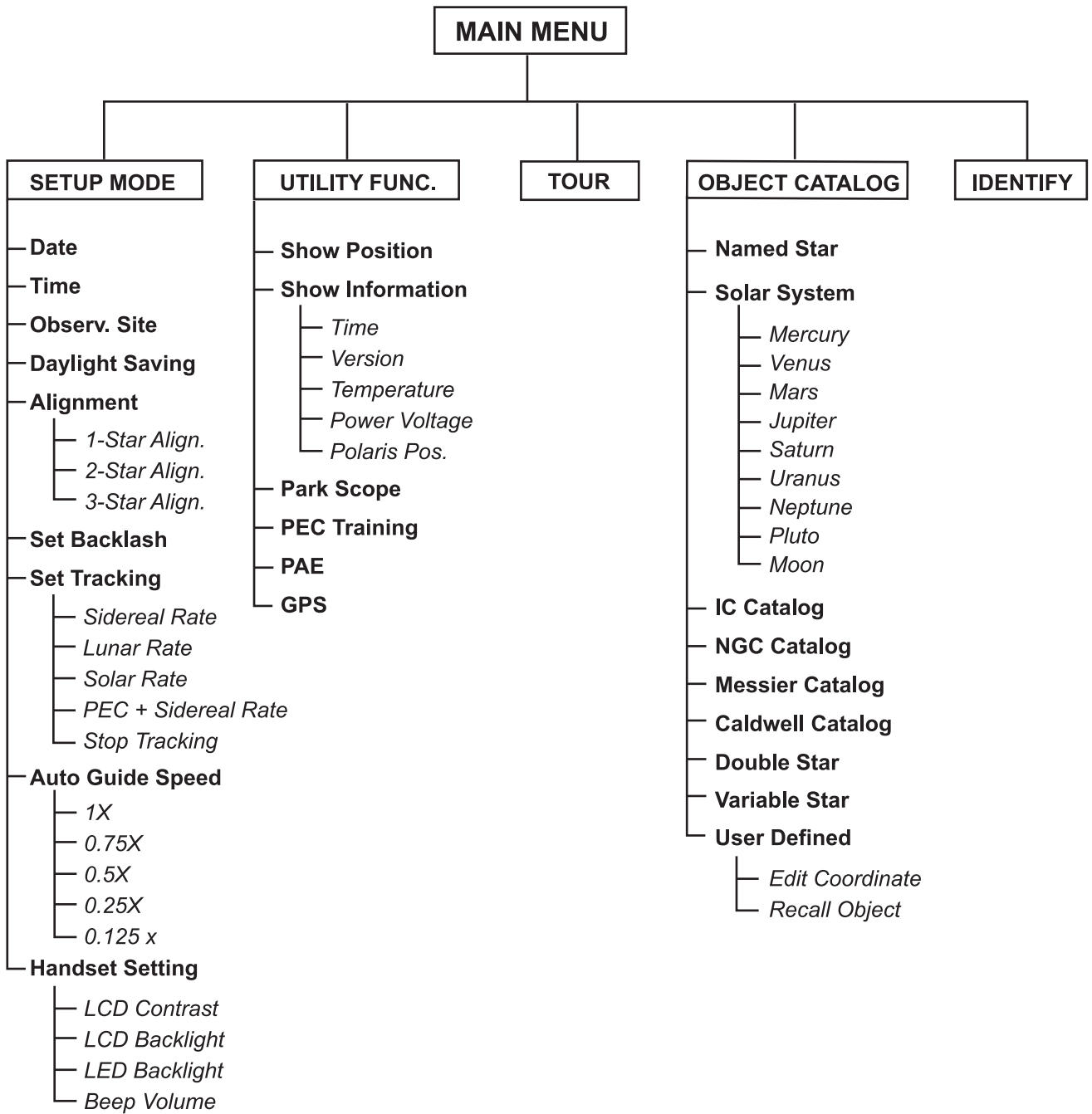

TECHNICAL SPECIFICATIONS

SynScan™ SPECIFICATIONS

Power Supply:	11 to 15 V DC 2Amp (Tip positive)
Motor type and resolution:	Microstep driven 1.8° stepper motors. Resolution: 0.144 arc sec (or 9,024,000 steps/rev.)
Slew speeds:	Rate 0 = 0.5X Rate 1 = 1X Rate 2 = 8X Rate 3 = 16X Rate 4 = 32X Rate 5 = 64X Rate 6 = 400X Rate 7 = 500X Rate 8 = 600X Rate 9 = 800X
Gear Ratio:	705
Tracking Rates:	Sidereal, Lunar, Solar
Tracking Modes:	R.A. tracking
Alignment Method:	One-Star Alignment, Two-Star Alignment, Three-Star Alignment
Database:	25 user defined objects. Complete M, NGC, and IC catalogues, Total 13,740 objects
Pointing Accuracy:	Up to 1 arc min

APPENDIX A - CONE ERROR CALIBRATION

Generally speaking the SynScan™ produces pointing and tracking accuracies adequate for most applications. However, if higher precision is required, for example for astro-photography, accurate polar alignment and "cone" error calibration may be required. See the manual for HEQ5/EQ6 mount for information on accurate polar alignment using the polarscope.

"Cone" error is a common inaccuracy found on all German equatorial mount. It is a result from the optical axis not being aligned to the R.A. axis of the mount. This affects the pointing accuracy of the SynScan™. Three-Star Alignment automatically compensates for the "Cone" error. If you choose One-Star or Two-Star Alignment method, you will need to perform manual mount calibration to eliminate the "cone" error. The following calibration procedure should be performed before the initial use of the telescope and periodically thereafter to ensure the accuracy.

Testing for Cone Error

This test is done at night using two bright stars located on the opposite side of the sky. Make sure the telescope is properly polar-aligned using the polarscope. Perform the One-star Alignment using an eastern star as the alignment star (see One-star Alignment). After the star alignment, choose a bright star on the western sky from the SynScan™ object database and have the telescope slew to the star. If the optical axis is perfectly aligned to the R.A. axis, the telescope will accurately put the star in the center of the eyepiece. In this case, there is no "cone" error in your telescope setup and you will not need to perform the calibration. It is acceptable if the star is slightly off-center as long as it is in the eyepiece view and close to the center. Many factors determine the pointing accuracy of the SynScan™, for example incorrect star alignment, R.A. or Dec lock knob being loose, or "cone" error. If your telescope puts the star outside the eyepiece view, you need to first determine whether it is "cone" error that causes the pointing inaccuracy. To find out, simply move the telescope in R.A. axis by pressing the Left or Right direction key. If the star can be moved into the eyepiece view without adjusting the Dec axis, it is likely that "cone" error exists in your telescope setup.

Calibration Procedure

1. Insert the illuminated reticle eyepiece. Make sure that the telescope is properly set up and balanced, and the finderscope is perfectly aligned with the telescope tube.



Step 2 to 4 is to identify R.A. and Dec movements in the reticle eyepiece. If you are already familiar with the movements, you may skip to step 5.



Required accessory: Illuminated reticle eyepiece with double crossline pattern. Depending on the design of your mounting plate (dovetail bar), modifications may be required. (See step 10 for the required mechanism on the mounting plate.)

2. Find any bright star and place it in the center of the eyepiece view.
3. Look into the eyepiece. Move the telescope in R.A. axis using the R.A. direction keys on the hand control while carefully observing the movement of the star.
4. Keep moving the the telescope in R.A. axis back and forth to keep the star within the eyepiece view. Rotate the eyepiece until the movement of the star becomes parallel to (or matches) any set of the lines (Fig.A-1). This set of lines will represent R.A. movement in the course of this procedure, and the perpendicular lines will represent Dec movement. Tighten the set screws to secure the eyepiece in place. Make sure that the eyepiece will remain stationary when the telescope is being rotated.
5. Point the telescope to North and set the latitude scale to your local latitude using the altitude adjustment T-bolts, or place Polaris on the crosshair of the polarscope if your polarscope is perfectly aligned with the rotation axis of the mount.

Fig.A-1

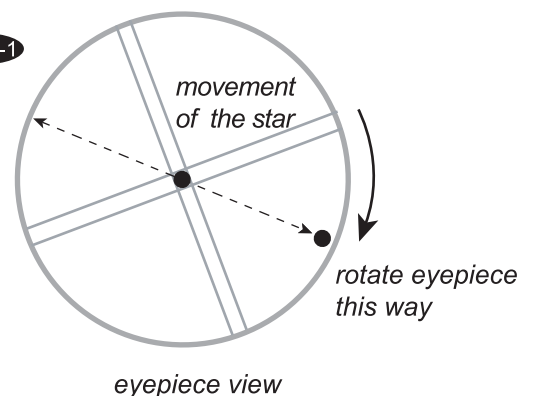

6. Loosen the R.A. lock knob and rotate the telescope around the R.A. axis until the counterweight shaft is parallel to the ground. (Fig.A-2)
7. Using the Dec direction key on the hand control, adjust the telescope in Dec so Polaris sits on the R.A. lines of the reticle eyepiece (Fig.A-3).
8. Without moving the R.A. axis, adjust the azimuth control knobs to bring Polaris to the center of the eyepiece (Fig.A-4). Adjustment in Dec axis using the hand control may be necessary.

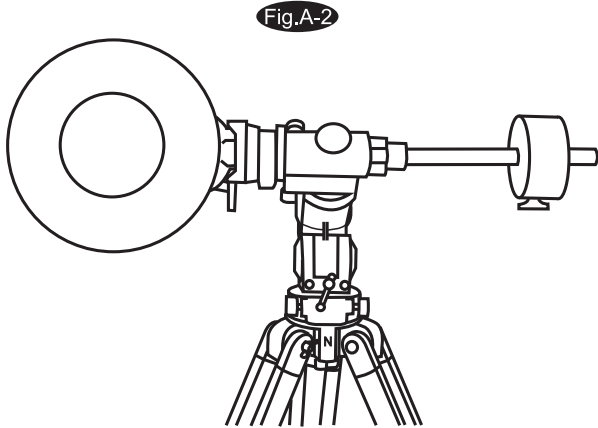

Fig.A-2

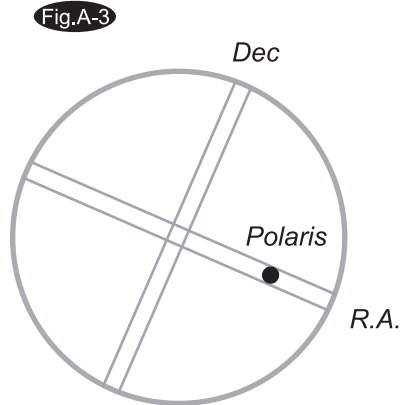

Fig.A-3

Place Polaris on the R.A. line

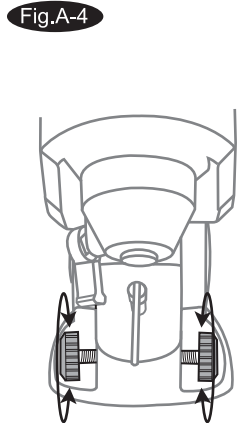

Fig.A-4

9. Loosen the R.A. lock knob and carefully rotate the telescope 180° in R.A. axis. (Fig.A-5). This should be done as accurate as possible using the R.A. setting circle.
10. Once again, adjust the telescope in Dec so Polaris sits on the R.A. lines of the reticle eyepiece (see Fig.A-3).
11. Now take a closer look at the mounting plate underneath the telescope tube. There should be a set of screws on each end, next to the tube ring locking screws (Fig.A-6). (If your mounting plate does not have these screws or screw holes, you will need to make modification to the plate.)

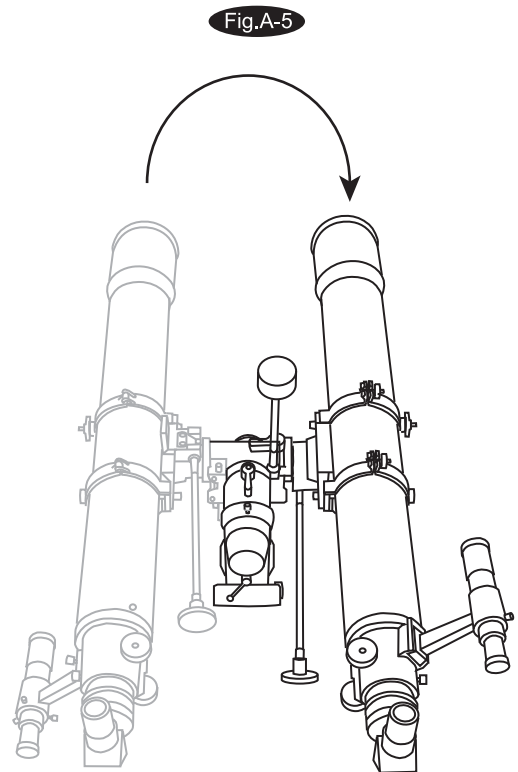

Fig.A-5

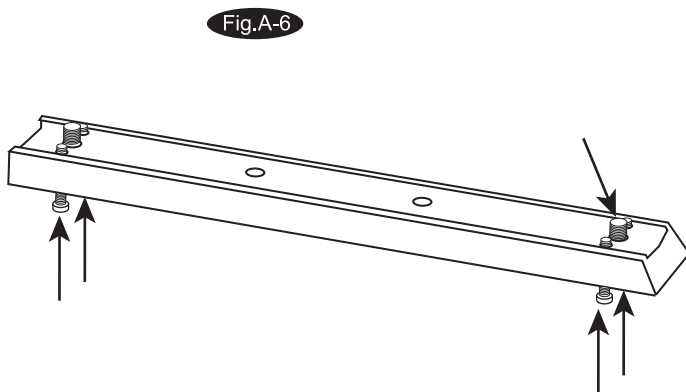
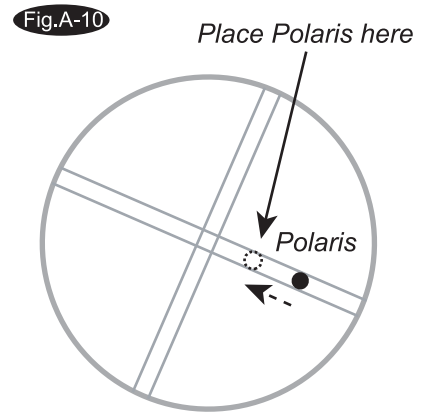
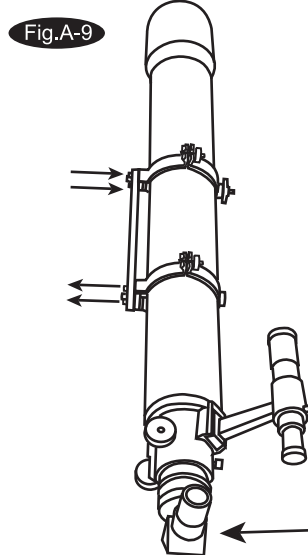
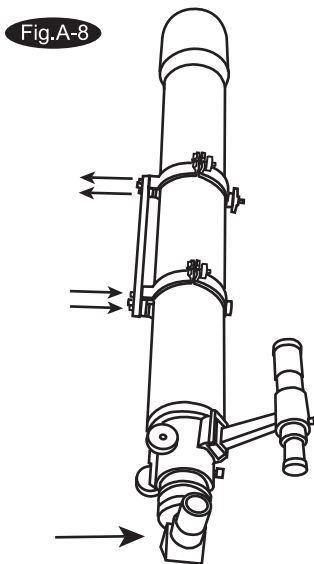
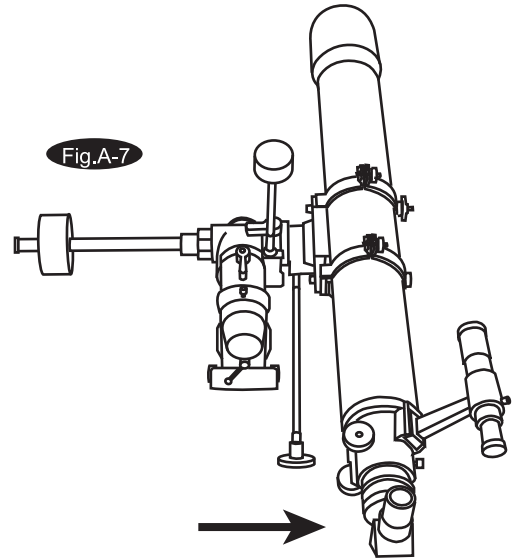

Fig.A-6

12. Carefully nudge the telescope in horizontal motion using only one finger while observing the movement of Polaris through the eyepiece (Fig.A-7). This is to determine which direction (left or right) moves Polaris closer to the center of the eyepiece.
13. Next step is to adjust the adjustment screws on the mounting plate according to your finding from step 12. If Polaris moves toward the center when the telescope is nudged toward your right hand side, You will need to loosen the adjustment screws near the front of the tube and tighten the ones closer to the back of the tube (Fig.A-8), and vice versa (Fig.A-9). Look into the eyepiece. Adjust the screws just enough to place Polaris **HALF** the distance back to the center (Fig.A-10).



14. Repeat step 7 to 13 until Polaris remains in the center of the eyepiece, or moves slightly around the center, when the mount is rotate about the R.A. axis.



This calibration method can be applied on both refracting and reflecting telescopes. Optical path of different telescope designs does not affect how the telescope tube and tube rings should be adjusted on the mounting plate.

APPENDIX B - RS-232 CONNECTION

The SynScan™ telescopes are designed to receive control commands sent from a computer via the RS-232 port and RS-232 cable. Once connected, the SynScan™ can be controlled by most popular planetarium software program. The SynScan™ will communicate with the personal computer at 9600 bits/sec, no parity and stop bit. All angles are communicated with 16 bit angle and communicated using ASCII hexadecimal.

Description	PC Command ASCII	Hand Control Response	Notes
Echo	Kx	X#	Useful to check communication
Goto Azm-Alt	B12AB, 4000	#	10 characters sent. B=Command, 12AB=Azm, comma, 4000=Alt. If command conflicts with slew limits, there will be no action.
Goto Ra-Dec	R34B, 12CE	#	Scope must be aligned. If command conflicts with slew limits, there will be no action.
Get Azm-Alt	Z	12AB, 4000#	10 characters returned, 12AB=Azm, comma, 4000=Alt, #
Get RA-Dec	E	34AB, 12CE#	Scope must be aligned.
Cancel Goto	M	#	
Is Goto in Progress	L	0# or 1#	0=No, 1=Yes: "0" is ASCII character zero
Is Alignment Complete	J	0# or 1#	0=No, 1=Yes
HC version	V	22	Two bytes representing V2.2
Stop/Start Tracking	Tx x= 0 (Tracking off) x= 1 (Alt-Az on) x= 2 (EQ-N) x= 3 (EQ-S)	#	Alt-Az tracking requires alignment
32-bit goto RA-Dec	r34AB0500,12CE0500	#	
32-bit get RA-Dec	e	34AB0500, 12CE0500#	The last two characters will always be zero.
32-bit goto Azm-Alt	b34AB0500,12CE0500	#	
32-bit get Azm-Alt	z	34AB0500, 12CE0500#	The last two characters will always be zero.

Physical Connection Diagram

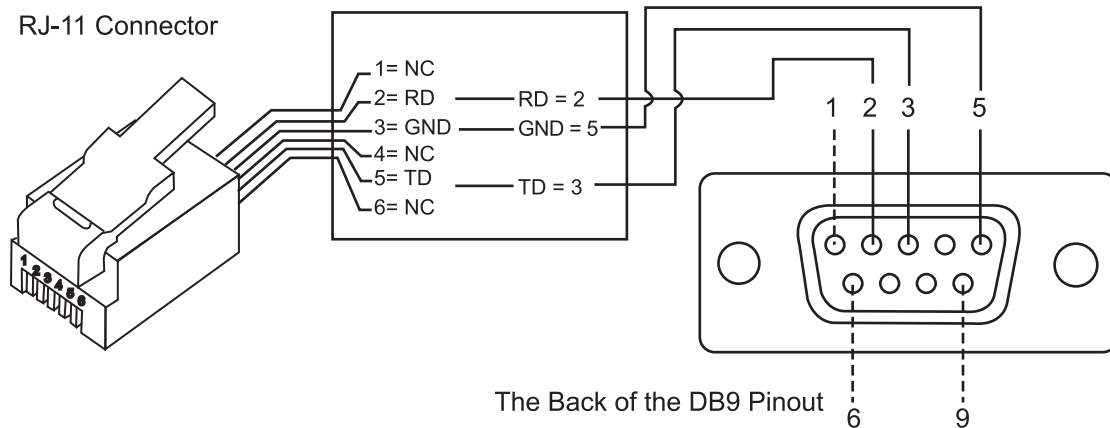

Additional RS232 Commands

Sending a track rate through RS232 to the hand control

1. Multiply the desired tracking rate (arc seconds /second) by 4. For example: if the desired track rate is 120 arc seconds/second (proximately 8 times of sidereal rate), then the TRACKRATE = 480.
2. Separate TRACKRATE into two bytes, such that (TRACKRATE =
3. TrackRateHighByte*256 + TrackRateLowByte). For example TRACKRATE = 480, then TrackRateHighByte = 1, TrackRateLowByte = 224.
To send a tracking rate, send the following 8 bytes:
 - a. Positive Azm tracking: 80, 3, 16, 6, TrackRateHighByte, TrackRateLowByte, 0, 0
 - b. Negative Azm tracking: 80, 3, 16, 7, TrackRateHighByte, TrackRateLowByte, 0, 0
 - c. Positive Alt tracking: 80, 3, 17, 6, TrackRateHighByte, TrackRateLowByte, 0, 0
 - d. Negative Alt tracking: 80, 3, 17, 7, TrackRateHighByte, TrackRateLowByte, 0, 0
4. The number 35 is returned from the hand control.

Sending a slow-Goto command through RS232 to the hand control

1. Convert the angle position to a 24bit number. Example: if the desired position is 220?, then POSITION_24BIT = (220/360)*224 = 10,252,743
2. Separate POSITION_24BIT into three bytes such that (POSITION_24BIT = PosHighByte * 65536 + PosMedByte * 256 + PosLowByte). Example: PosHighByte = 156, PosMedByte = 113, PosLowByte = 199
3. Send the following 8 bytes:
 - a. Azm Slow Goto: 80, 4, 16, 23, PosHighByte, PosMedByte, PosLowByte, 0
 - b. Alt Slow Goto: 80, 4, 17, 23, PosHighByte, PosMedByte, PosLowByte, 0
4. The number 35 is returned from the hand control.

Reseting the position of Az or Alt

1. Convert the angle position to a 24bit number, same as Slow-Goto example.\
2. Send the following 8 bytes:
 - a. Azm Set Position: 80, 4, 16, 4, PosHighByte, PosMedByte, PosLowByte, 0
 - b. Alt Set Position: 80, 4, 17, 4, PosHighByte, PosMedByte, PosLowByte, 0
3. The number 35 is returned from the hand control.

APPENDIX C - STANDARD TIME ZONES OF THE WORLD

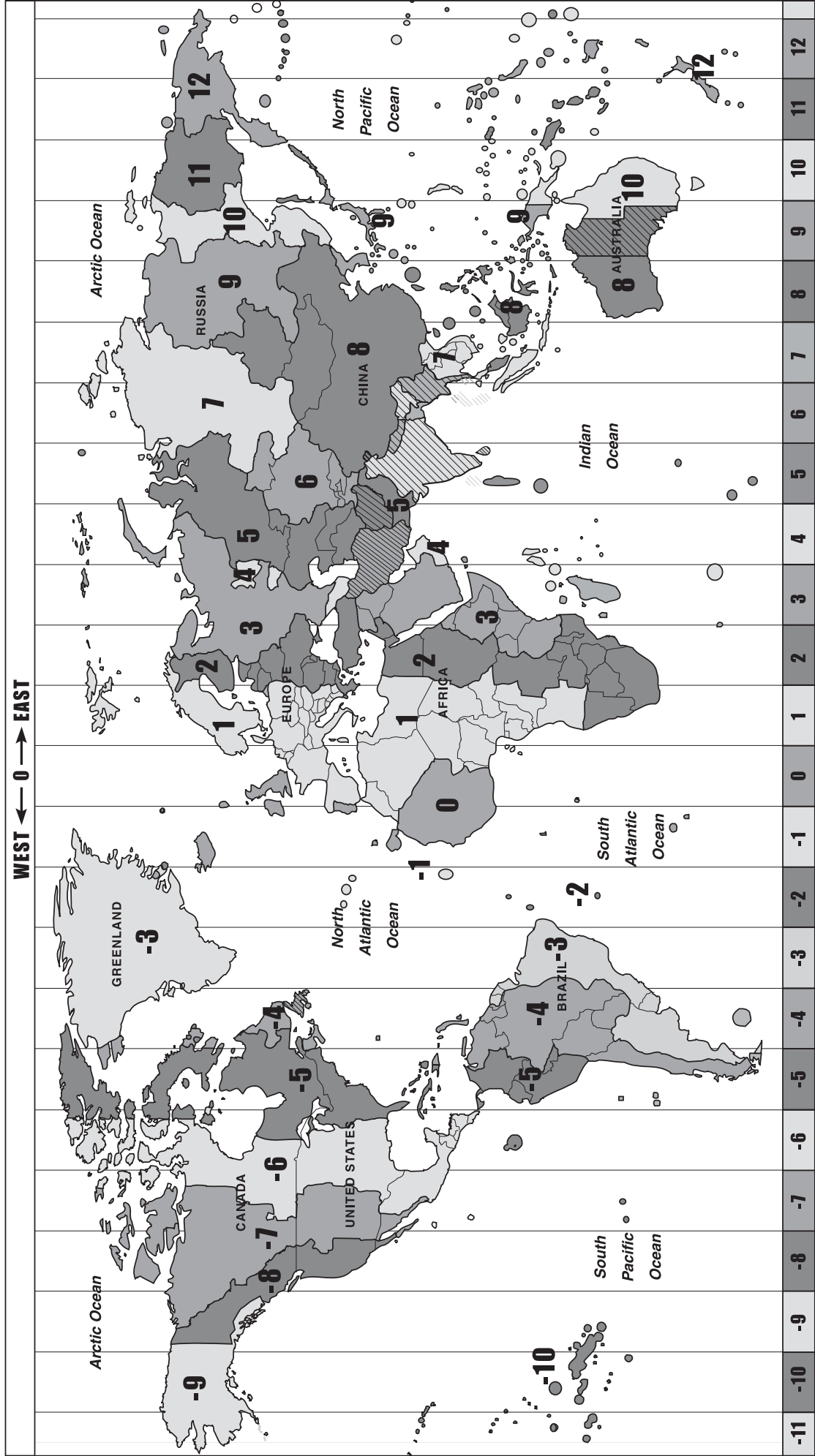

SynScan™



NEVER USE YOUR TELESCOPE TO LOOK DIRECTLY AT THE SUN. PERMANENT EYE DAMAGE WILL RESULT. USE A PROPER SOLAR FILTER FIRMLY MOUNTED ON THE FRONT OF THE TELESCOPE FOR VIEWING THE SUN. WHEN OBSERVING THE SUN, PLACE A DUST CAP OVER YOUR FINDERSCOPE OR REMOVE IT TO PROTECT YOU FROM ACCIDENTAL EXPOSURE. NEVER USE AN EYEPiece-TYPE SOLAR FILTER AND NEVER USE YOUR TELESCOPE TO PROJECT SUNLIGHT ONTO ANOTHER SURFACE, THE INTERNAL HEAT BUILD-UP WILL DAMAGE THE TELESCOPE OPTICAL ELEMENTS.